

# B3420



## INTERFACES AVAILABLE:

Resolution

Sensor

Sensor Format

Pixel Size

Frame Rate Standard Clock

Frame Rate Overclocked

Maximum Frame Rate

Minimum S/N Ratio

Output Format

Analog Gain Control

Black Level Control

Digital Gain and Offset

RGB Gain and Offset

White Balance

Shutter Speed

Exposure Control

Long Integration

Regions of Interest (ROI)

Binning H/V

Trigger Inputs

Trigger Options

Trigger Modes

Double Trigger (PIV) Interframe

External Inputs/Outputs

Strobe Output

RS232 Interface

Pulse Generator

Image Overlay

Image Enhancement

Internal DDR Memory

On Board FIFO (GEV &amp; PoE)

Gamma Correction

Data Corrections

Minimum Illumination

Lens Mount

Video Iris Control

Iris, Zoom Focus Control

Supply Input Range

Power Consumption

Size – Width/Height

Size – Length

Weight

Vibration, Shock

Environmental

Humidity

MTBF

Regulatory

Camera Link® Base (PoCL), GigE Vision, PoE, CoaXPress  
3388 x 2712

ICX-814 EXview HAD CCD II

12.50mm (H) x 10.00mm (V) 15.97mm diagonal

1.0" optical format

3.69  $\mu\text{m}$ 

40 MHz / 6.9 fps

50 MHz / 8.6 fps

41 fps

60dB

Mono CCD: 8, 10, 12, 14-bit (Single only)

Color CCD: 8, 10, 12, RGB 24 (Bayer only)

Manual, Auto: 0 - 36dB 1024 steps

Manual, 1024 steps

Manual

Manual

Manual, auto, off

1 $\mu\text{s}$ /step, 1/500,000 to 1/8 sec (nom)

Manual, auto, external

Up to 16 seconds

7 ROIs, any line to any line, any pixel to any pixel

1x, 2x, 3x, 4x, 8x (Independent for H &amp; V)

External (TTL via IN1/IN2), pulse generator,

software, computer

Level, edge, pulse width, internal exposure,

up to 16 seconds trigger delay, debounce

Free-run, standard, double, fast, asynchronous,

frame accumulation

Time: 200 nanoseconds

2 IN, 2 OUT, user programmable

2 strobes, programmable position and duration

Yes, programmable

Yes, programmable

Optical center, programmable H &amp; V lines

Threshold, contrast enhancement, knee correction,

horizontal flip, negative image, bit shift (+/- 7 places)

2Gb (256 MB)

1Gb (128 MB)

G=1.0, G=0.45, user upgradeable LUT

Defective/hot pixel correction (static, dynamic), FFC,

black level, vertical smear

1 Lux, F/ 1.4

C-Mount

Auto, programmable

Manual, user programmable (motorized lens, custom)

12VDC (10V - 15V), 1.5 A inrush

CLB 3.5 W, GEV 5.1W, PoE 6.2W, CXP TBD

46mm (W) x 46mm (H) – Applies to all interfaces

CLB 59.6mm (L), GEV 77.5mm (L), PoE 91.1mm (L),

CXP 67.2mm (L)

CLB 325g, GEV 398g, PoE 534g, CXP 374g

100g (20-200) HZ XYZ, 1000g

-40°C to +85°C Operating, -50°C to +90°C Storage

10% to 90% non-condensing

&gt;660,000 hours @ 40°C (Telcordia SR-332)

FCC 15 part A, CE, RoHS

**IMPERX:** Technically superior products, full tech support, rapid-response customer care. "Bobcat 2.0" adds many new features, lens control, more memory and enhanced image quality. Each easy to use Bobcat is supported by IMPERX professionals.

Monochrome with Microlens ICX-814  
(Excludes lens & light source characteristics)

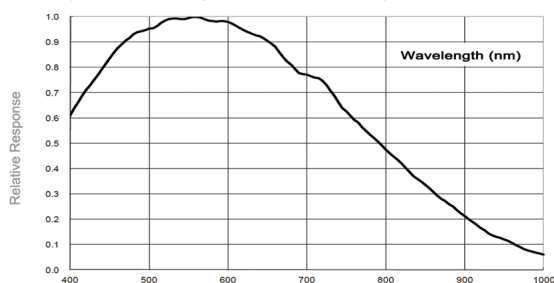

Color with Microlens  
(Excludes lens & light source characteristics)

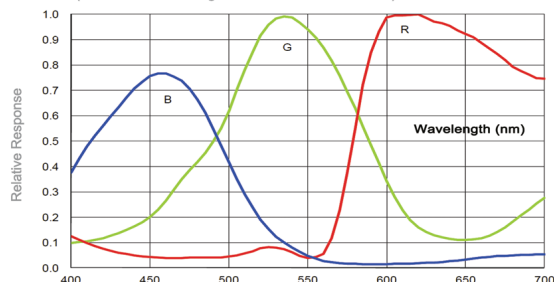

## GigE Vision(Without PoE)

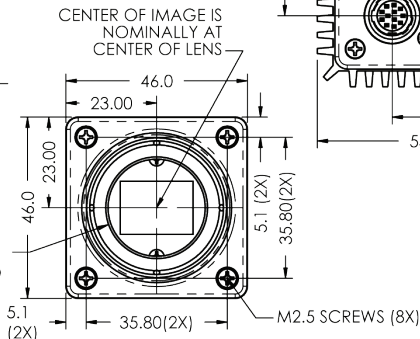
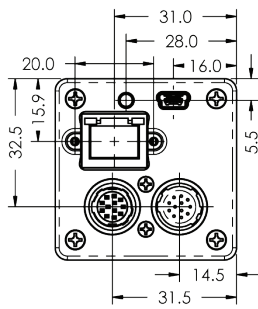
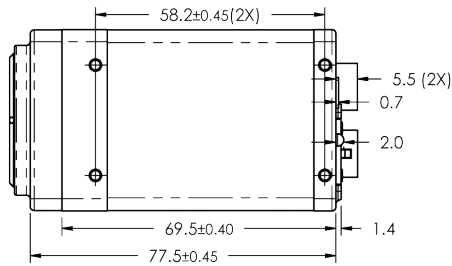

## GigE Vision(With PoE)

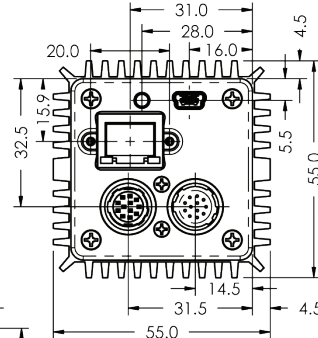
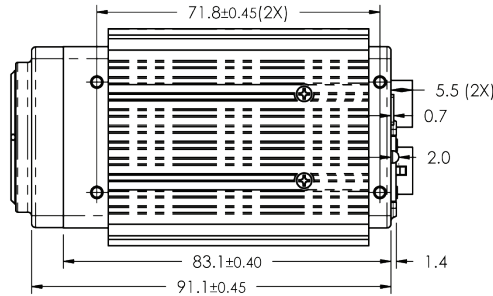

## Camera Link

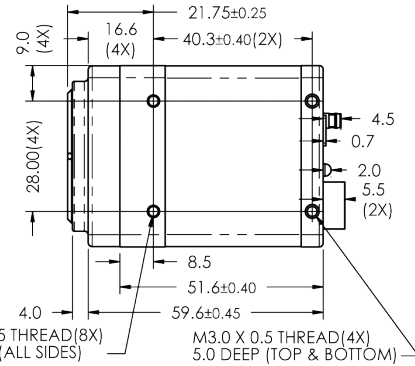

NOTE:  
DATUM "A" REFERS TO  
THE IMAGE PLANE  
(TOP OF IMAGING DIE)

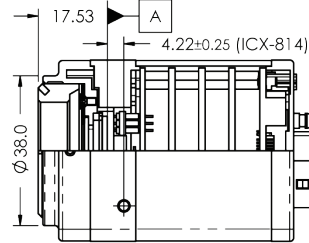

COMMON IMAGE PLANE DISTANCE

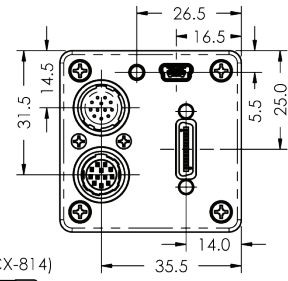

### Hirose Connectors Power and I/O Interface

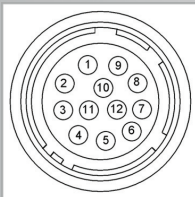

- |                   |                 |
|-------------------|-----------------|
| 1 12V DC Return * | 7 OUT1 Signal   |
| 2 +12V DC*        | 8 IN1 Signal    |
| 3 IRIS VCC        | 9 IN2 Signal    |
| 4 IRIS Video      | 10 IN1/2 Return |
| 5 IRIS Return     | 11 Reserved     |
| 6 OUT1/2 Return   | 12 OUT2 Signal  |

Connector: Hirose HR 10A- 10R- 12PB(71)  
\*Not connected for CXP

### Lens Control/RS232

See manual for PIN information

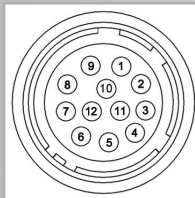

- |               |             |
|---------------|-------------|
| 1 IRIS Return | 7 FOCUS +   |
| 2 IRIS VCC    | 8 ZOOM -    |
| 3 IRIS Video  | 9 ZOOM +    |
| 4 IRIS -      | 10 UART_COM |
| 5 IRIS +      | 11 UART_RX  |
| 6 FOCUS -     | 12 UART_TX  |

Connector: Hirose HR 10A- 10R- 12SB(71)

## CoaXPress

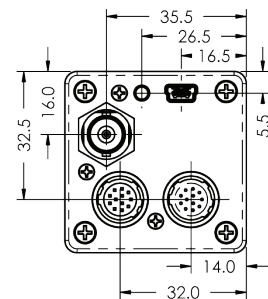
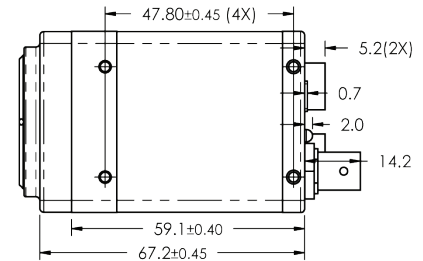

## B3420 Ordering Information

### Interfaces available

- Camera Link® Base (CLB)
- GigE Vision (GEV / PoE)
- CoaXPress (CXP)

### Sensor types available

- Monochrome
- Bayer Color

### Accessories (Sold separately)

- PS12v04-Power Supply w/ 1 input and 1 output
- PS12v05-Power Supply (as above) and Video Iris

**IMPERX**

WWW.IMPERX.COM



bobcat-B3420,Rev1