

B4821



IMPERX: Technically superior products, full tech support, rapid-response customer care. “Bobcat 2.0” adds many new features, lens control, more memory and enhanced image quality. Each easy to use Bobcat is supported by IMPERX professionals.

INTERFACES AVAILABLE:

Resolution

Sensor

Sensor Format

Pixel Size

Frame Rate Standard Clock

Frame Rate Overclocked

Maximum Frame Rate

Minimum S/N Ratio

Output Format

Analog Gain Control

Black Level Control

Digital Gain and Offset

RGB Gain and Offset

White Balance

Shutter Speed

Exposure Control

Long Integration

Regions of Interest (ROI)

Binning H/V

Trigger Inputs

Trigger Options

Trigger Modes

Double Trigger (PIV) Interframe

External Inputs/Outputs

Strobe Output

RS232 Interface

Pulse Generator

Image Overlay

Image Enhancement

Internal DDR Memory

On Board FIFO (GEV & PoE)

Gamma Correction

Data Corrections

Minimum Illumination

Lens Mount

Video Iris Control

Iris, Zoom Focus Control

Supply Input Range

Power Consumption

Size – Width/Height

Size – Length

Weight

Vibration, Shock

Environmental

Humidity

MTBF

Regulatory

Camera Link® Base (PoCL), GigE Vision, PoE, CoaXPress
4896 x 3264 (std.), 4920 x 3280 (max.)

KAI-16050, CCD

27.06mm (H) x 18.04mm (V) 32.36mm diagonal
APS-H format

5.50 µm

30 MHz / 3.1 fps

40 MHz / 4.2 fps

21 fps

60dB

Mono CCD: 8, 10, 12, 14-bit (Single only)

Color CCD: 8, 10, 12, RGB 24 (Bayer only)

TRUESENSE Sparse CFA

Manual, Auto: 0 - 36dB 1024 steps

Manual, 1024 steps

Manual

Manual

Manual, auto, off

1µs/step, 1/250,000 to 1/3 sec (nom)

Manual, auto, external

Up to 16 seconds

7 ROIs, any line to any line, any pixel to any pixel

1x, 2x, 3x, 4x, 8x (Independent for H & V)

External (TTL via IN1/IN2), pulse generator,

software, computer

Level, edge, pulse width, internal exposure,

up to 16 seconds trigger delay, debounce

Free-run, standard, double, fast, asynchronous,

frame accumulation

Time: 200 nanoseconds

2 IN, 2 OUT, user programmable

2 strobes, programmable position and duration

Yes, programmable

Yes, programmable

Optical center, programmable H & V lines

Threshold, contrast enhancement, knee correction,

horizontal flip, negative image, bit shift (+/- 7 places)

2Gb (256 MB)

1Gb (128 MB)

G=1.0, G=0.45, user upgradeable LUT

Defective/hot pixel correction (static, dynamic), FFC,

black level, vertical smear

1 Lux, F/ 1.4

F-Mount (Default), C, M42, EOS, Rodenstock,

Custom OEM

Auto, programmable

Manual, user programmable

12VDC (10V - 15V), 1.5 A inrush

CLB 3.8 W, GEV 5.8W, PoE 6.9W, CXP TBD

60mm (W) x 60mm (H) – Applies to all interfaces

CLB 53.1mm (L), GEV 70.8mm (L), PoE 84.4mm (L),

CXP 60.1mm (L)

CLB 354g, GEV 404g, PoE 545g, CXP 384g

100g (20-200) HZ XYZ, 1000g

-40°C to +85°C Operating, -50°C to +90°C Storage

10% to 90% non-condensing

>660,000 hours @ 40°C (Telcordia SR-332)

FCC 15 part A, CE, RoHS

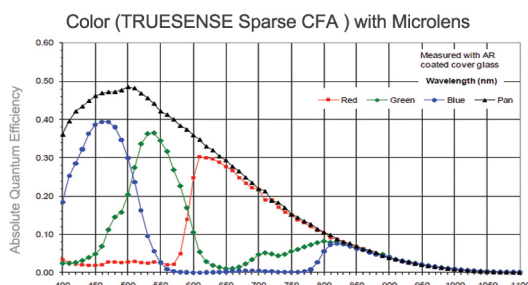
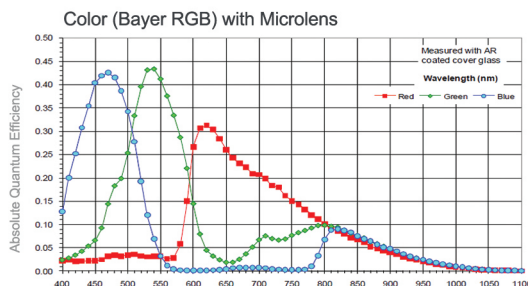
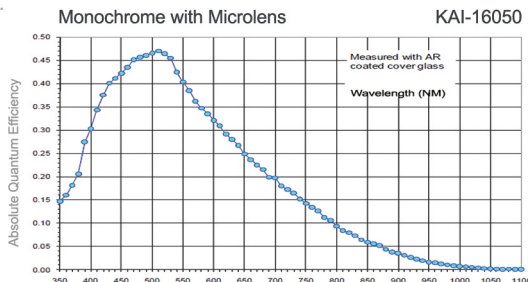

BOBCAT 2.0 B4821 Specifications

GigE Vision (Without PoE)

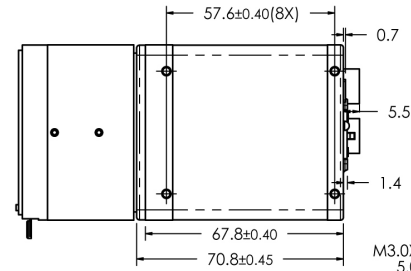

Camera Link

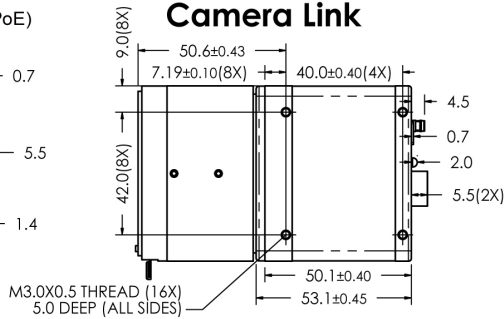

CoaXPress

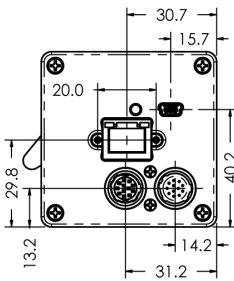
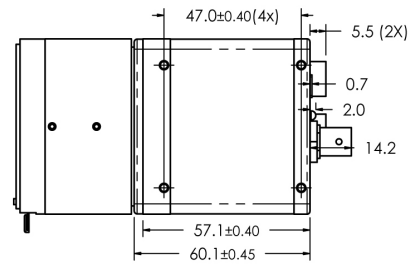

CENTER OF IMAGE IS NOMINALLY AT CENTER OF LENS

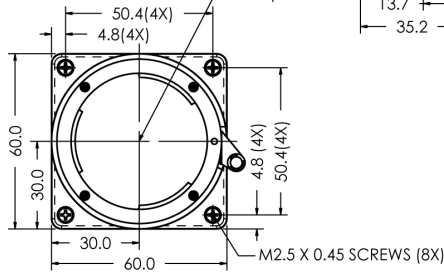

COMMON FRONT VIEW

NOTE: DATUM "A" REFERS TO THE IMAGE PLANE (TOP OF IMAGING DIE)

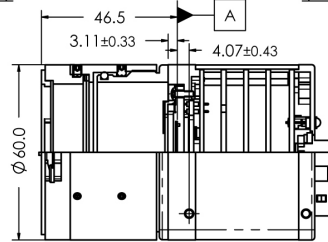

COMMON IMAGE PLANE DISTANCE

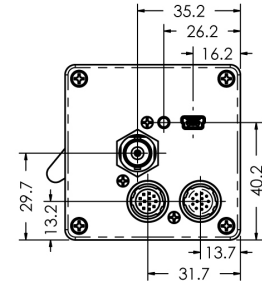

Hirose Connectors

Power and I/O Interface

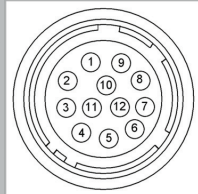

- | | |
|-------------------|-----------------|
| 1 12V DC Return * | 7 OUT1 Signal |
| 2 +12V DC* | 8 IN1 Signal |
| 3 IRIS VCC | 9 IN2 Signal |
| 4 IRIS Video | 10 IN1/2 Return |
| 5 IRIS Return | 11 Reserved |
| 6 OUT1/2 Return | 12 OUT2 Signal |

Connector: Hirose HR 10A- 10R- 12PB(71)

*Not connected for CXP

Lens Control/RS232

See manual for PIN information

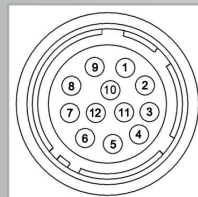

- | | |
|---------------|-------------|
| 1 IRIS Return | 7 FOCUS + |
| 2 IRIS VCC | 8 ZOOM - |
| 3 IRIS Video | 9 ZOOM + |
| 4 IRIS - | 10 UART_COM |
| 5 IRIS + | 11 UART_RX |
| 6 FOCUS - | 12 UART_TX |

Connector: Hirose HR 10A- 10R- 12SB(71)

* Canon EOS control available

PoE

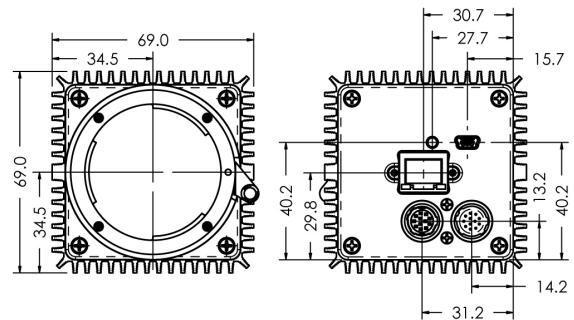
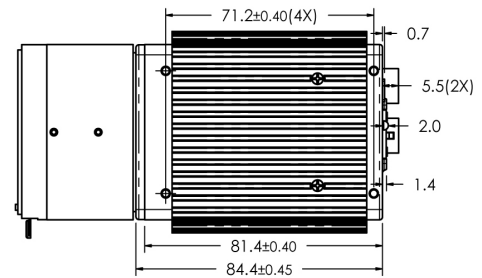

B4821 Ordering Information

Interfaces available

Camera Link® Base (CLB)
GigE Vision (GEV / PoE)
CoaXPress (CXP)

Sensor types available

Monochrome
Bayer Color
TRUESENSE Sparse CFA

Accessories (Sold separately)

PS12v04-Power Supply w/ 1 input and 1 output
PS12v05-Power Supply (as above) and Video Iris

IMPERX

WWW.IMPERX.COM



bobcat-B4821_Rev1